

Description: User Manual GigaCore 10.
REVISION: 20220623-REV 2.8.7

Luminex
NETWORK INTELLIGENCE

GigaCore 10 USER MANUAL



GIGACORE PRODUCT FAMILY
GigaCore 10

THANKS FOR CHOOSING LUMINEX

MADE IN BELGIUM

General information



The lightning flash with arrowhead symbol, within an equilateral triangle, is intended to alert the user to the presence of uninsulated "dangerous voltage" within the product's enclosure that may be of sufficient magnitude to constitute a risk of electric shock to persons.

L'éclair avec une flèche à l'intérieur d'un triangle équilatéral est destiné à attirer l'attention de l'utilisateur sur la présence d'une « tension dangereuse » non isolée à l'intérieur de l'appareil, pouvant être suffisamment élevée pour constituer un risque d'électrocution.



The exclamation point within an equilateral triangle is intended to alert the user to the presence of important operating and maintenance (servicing) instructions in the literature accompanying the appliance.

Le point d'exclamation à l'intérieur d'un triangle équilatéral est destiné à attirer l'attention de l'utilisateur sur la présence d'instructions importantes sur l'emploi ou la maintenance (réparation) de l'appareil dans la documentation fournie.

CAUTION

TO REDUCE THE RISK OF FIRE OR ELECTRIC SHOCK, DO NOT EXPOSE THIS APPARATUS TO RAIN OR MOISTURE.

AVERTISSEMENT

POUR RÉDUIRE LES RISQUES D'INCENDIE OU DE DÉCHARGE ÉLECTRIQUE, N'ÉPOSEZ PAS CET APPAREIL À LA PLUIE OU À L'HUMIDITÉ.

CAUTION

NO USER SERVICEABLE PARTS INSIDE. REFER SERVICING TO QUALIFIED SERVICE PERSONEL.

AVERTISSEMENT

AUCUNE PIÈCE CONTENUE À L'INTÉRIEUR NE PEUT ÊTRE RÉPARÉE PAR L'UTILISATEUR, VEUILLEZ CONFIER TOUTE RÉPARATION À UN PERSONNEL QUALIFIÉ.

FCC Compliance Statement:

This device complies with Part 15 of the FCC Rules. Operation is subject to the following two conditions: (1) this device may not cause harmful interference, and (2) this device must accept any interference received; including interference that may cause undesired operation.

IMPORTANT NOTICE: DO NOT MODIFY THIS UNIT!



This product, when installed as indicated in the instructions contained in this manual, meets FCC requirements. Modifications not expressly approved by Luminex Lighting Control Equipment nv may void your authority, granted by the FCC, to use the product.

This Equipment has been tested and found to comply with the limits for a Class A digital device, pursuant to Part 15 of the FCC rules. These limits are designed to provide reasonable protection against harmful interference when the equipment is operated in a commercial environment.

This equipment generates, uses and can radiate radio frequency energy and, if not installed and used in accordance with the instructions, may cause harmful interference to radio communications. Operation of this equipment in a residential area is likely to cause harmful interference in which case the user will be required to correct the interference at his own expense.

Industry Canada compliance statement

This Class A digital apparatus complies with Canadian ICES-003. Cet appareil numérique de la classe A est conforme à la norme NMB-003 du Canada.

European Community Compliance Statement

This is a class A product. In a domestic environment, this product may cause radio interference in which case the user may be required to take adequate measures.

Disposal of Waste Equipment by users in the European Union

Information for Users on Collection and Disposal of Old Equipment.

This symbol on the products, packaging, and/or accompanying documents means that used electrical and electronic products should not be mixed with general household waste.

For proper treatment, recovery, and recycling of old products, please take them to applicable collection points, in accordance with your national legislation and the Directives 2002/96/EC. By disposing of these products correctly, you will help to save valuable resources and prevent any potential negative effects on human health and the environment which could otherwise arise from inappropriate waste handling. For more information about collection and recycling of old products, please contact your local municipality, your waste disposal service, or the point of sale where you purchased the items.

[For business users in the European Union]

If you wish to discard electrical and electronic equipment, please contact your dealer or supplier for further information.

[Information on Disposal in other Countries outside the European Union]

This symbol is only valid in the European Union. If you wish to discard these items, please contact your local authorities or dealer and ask for the correct method of disposal.

Warranty information

Limited warranty

Unless otherwise stated, your product is covered by a two (2) years parts and labour limited warranty. It is the owner's responsibility to furnish receipts or invoices for verification of purchase, date, and dealer or distributor. If purchase date cannot be provided, date of manufacture will be used to determine warranty period.

Returning under warranty

Any product unit or parts returned to Luminex LCE must be packaged in a suitable manner to ensure the protection of such product unit or parts, and such package shall be clearly and prominently marked to indicate that the package contains returned product units or parts.

Accompany all returned product units or parts with a written explanation of the alleged problem or malfunction.

Freight

All shipping will be paid by the purchaser. Items under warranty shall have return shipping paid by the manufacturer only in the European Union. Under no circumstances will freight collect shipments be accepted.

Prepaid shipping does not include rush expediting such as air freight. Air freight can be sent customer collect in the European Union. Warranty is void if the product is misused, damaged, modified in any way, or for unauthorized repairs or parts.

CONTENTS

1. APPLICATIONS	5	4. CONFIGURATION	14
2. INSTALLATION.....	6	4.1 Connecting to the web interface.....	14
2.1 Mounting the device.....	6	4.2 Status Page.....	14
Rack mount.....	6	4.3 Global Page.....	15
Rack mount - two devices.....	6	4.4 RlinkX	19
Truss mount.....	7	4.5 Groups (VLANs)	20
Wall mount.....	8	4.6 PoE (LU 01 00036-POE only).....	22
2.2 Power up the device.....	8	4.7 Profile Manager	24
2.3 Description.....	9	5. RESET	26
2.4 LED Indicators.....	10	5.1 Reset	26
2.5 Connecting to the web interface.....	10	5.2 Reload Default.....	26
2.6 Reset	10	5.3 Factory Reset.....	27
3. GIGACORE FEATURES EXPLAINED.....	11	6. TECHNICAL SUPPORT.....	27
3.1 RlinkX	11	7. APPENDIX.....	28
3.2 Groups (VLANs)	12	7.1 Technical data.....	28
3.3 MultiLinkX.....	12		

VERSATILE.
EFFORTLESS.
RELIABLE.

WELCOME TO YOUR GIGACORE 10

Assign all your lighting, audio and video protocols to different colour groups and send them over the same network. Luminex takes care of the rest and makes sure every device receives the right

signal (ArtNet, sACN, MANet, Dante™, RAVENNA/AES67, Q-LAN, PTPv2 IEEE1588-2008 and many more ...).

1. APPLICATIONS

A few examples of applications where the GigaCore can be used:

- Convention centers
- Architectural lighting
- Multimedia shows
- Schools
- Theme parks
- Theaters, operas
- Festivals, tours

Typical Application:

- ⌚ PTPv2 / Precision Time Protocol
- ⚡ PoE / Power over Ethernet

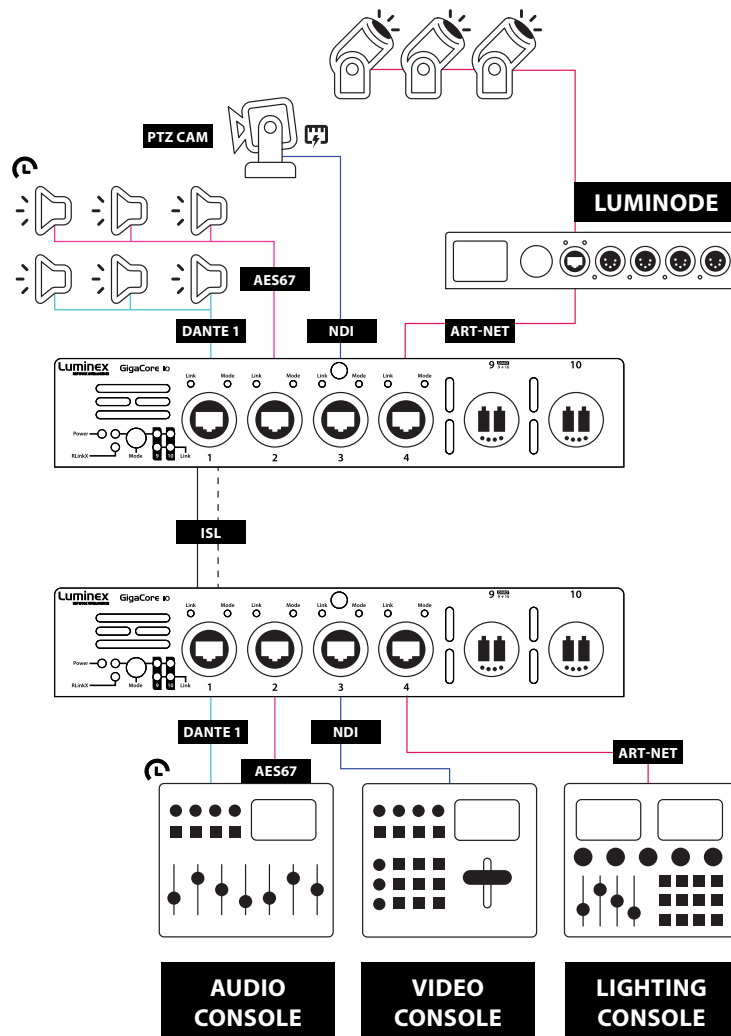

2. INSTALLATION

2.1 Mounting the device

GigaCore 10 is a device that can be mounted in a truss as well as in a rack. Please read the following instructions to make sure the device is mounted and secured correctly.

■ RACK MOUNT

In case you want to mount your GigaCore 10 in a standard 19-inch rack, you must attach the included mounting ears. Connect the longest ear (A) to the right-hand side of the device with 4 screws, re-used from the device. Attach the shorter ear (B) to the left-hand side again with the 4 screws.

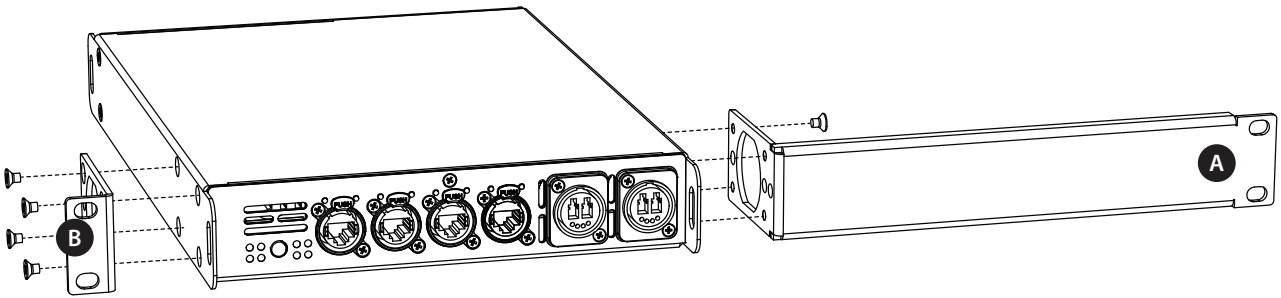

■ RACK MOUNT - TWO DEVICES

In case you want to mount two GigaCore 10 devices in a standard 19-inch rack you can mount the two devices together. This is a way to save space as the two devices will only consume a single row in your 19-inch rack.

Connect the shortest ear (C) to the left-hand side of the first device with 4 screws, re-used from the device. Attach the other shortest ear (D), delivered with the second device, to the right-hand side

of the second device, again with 4 screws. Use a pair of mounting brackets (E) to connect the two devices in the middle on the front side. Use a second pair of mounting brackets (E), delivered with the second device, to connect the devices at the rear. Each pair of brackets must be mounted with 2 screws.

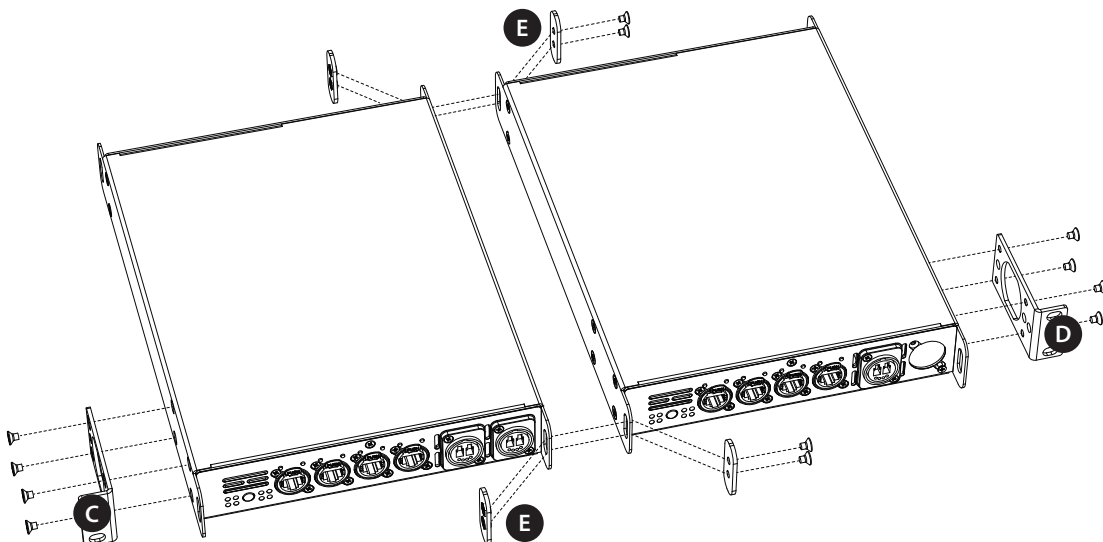

To combine a GigaCore 10 device with a Luminex half 19" device, style LumiNode 4, the mounting procedure differs a little. The bolt (F), not included, replaces the rear couplers at the rear side of the devices. Use the correct bolt, M10x20, with a screw wire no longer as 20mm. You can order this part from Luminex (Part Number: R 90 01042)

Screw the bolt, through the LumiNode 4 back ear, into the side M10 insert and tighten it. The rest of the mounting procedure remains the same.

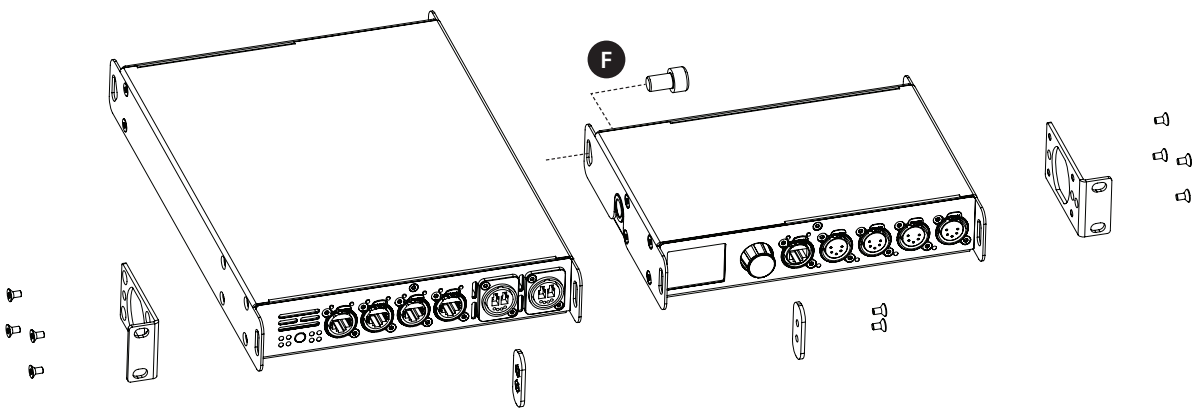

■ TRUSS MOUNT

To mount a GigaCore 10 in a truss, you must attach a M10 clamp (G) to the M10 insert (H). After that, you can mount the clamp to

the truss bars. Please also secure the device by attaching a safety line directly to the truss bars as well (I).

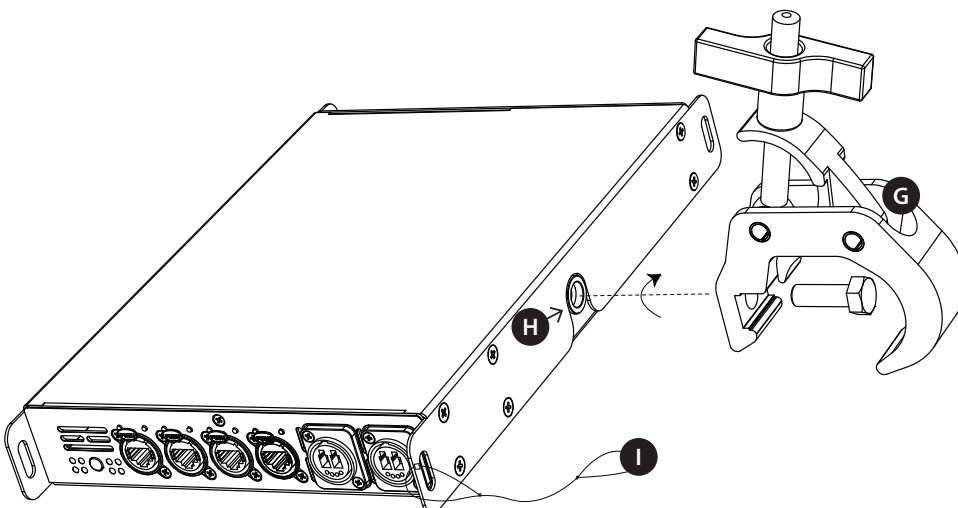

WALL MOUNT

To mount a GigaCore 10 on the wall, you must attach the wall mount brackets (A) (LU_10_00126). Connect the brackets with 4 screws, re-used from the device.

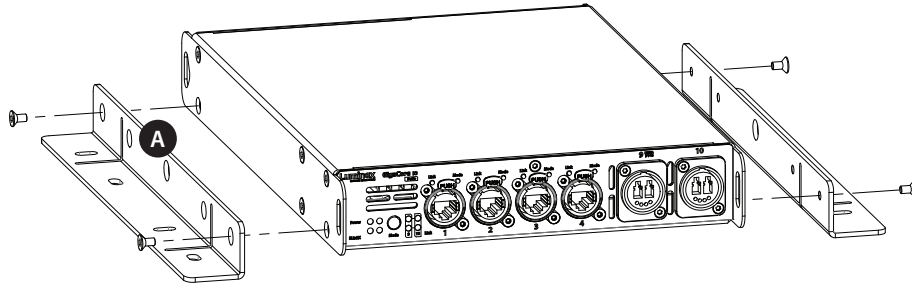

2.2 Power up the device

Power-up the device with a power cable with Neutrik powerCON TRUE1 connection (J) (please contact your local dealer if you don't have a suitable power cable on hand). The device will automatically switch on. To shut it down after use, just un-plug the power cable again. After connecting the power cable correctly, by default the power LED indicator on the front panel will light up in green.

The GigaCore 10 requires standard AC power distribution from 100-240VAC, 50/60Hz. Current required depends on the model.

The mating Neutrik® powerCON® TRUE1 connector is supplied; however, you will need to purchase or construct a cable appropriate for your application.

When installing a new connector please refer to the following wire colour code reference:

WIRE*	CONNECTION
Green/Yellow	AC Ground
Blue	AC Neutral
Brown	AC Line

* International (Harmonised) Standard

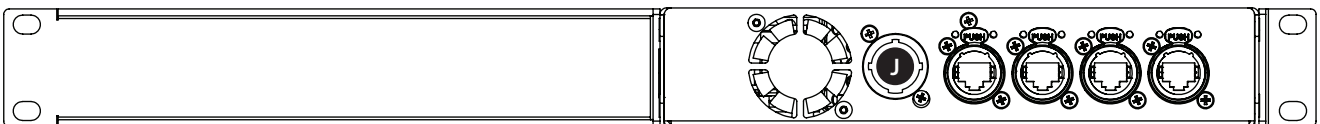

2.3 Description

2.3.1 Front Panel

■ (A) STATUS LEDs:

- **Power:** Indicates the status of the power supply.
- **PoE:** Indicates the status of the PoE functionality and the PoE supplies (GigaCore 10 with PoE only).
- **RLinkX:** Indicates the RLinkX status.

■ (B) MODE:

- **Mode LED:** Indicates the selected state for the port Mode LEDs (see the "LED indicators" section for more details).
- **Mode button:** Use this button to browse through the different states for the port Mode LEDs.

■ (C) OPTICAL PORT LEDs:

- **2x Optical Port Mode:** According to the selected state, the LED will show different colours.
- **2x Optical Port Link/Speed:** Shows the current speed and link activity of a port.

■ (D) ETHERCON PORTS:

- **4x EtherCon** 10/100/1000Mbps port.

■ (E) OPTICAL FIBRE:

- **1x Quad core or 2x Duo core** fibre optic connector.

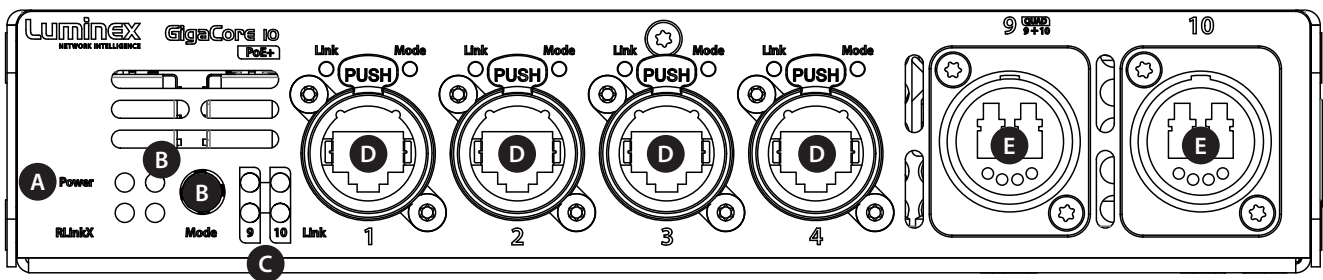

2.3.1 Rear Panel

■ (F) POWER:

- **1x Neutrik powerCON TRUE1** inlet.

■ (G) ETHERCON PORTS:

- **4x EtherCon** 10/100/1000Mbps port.

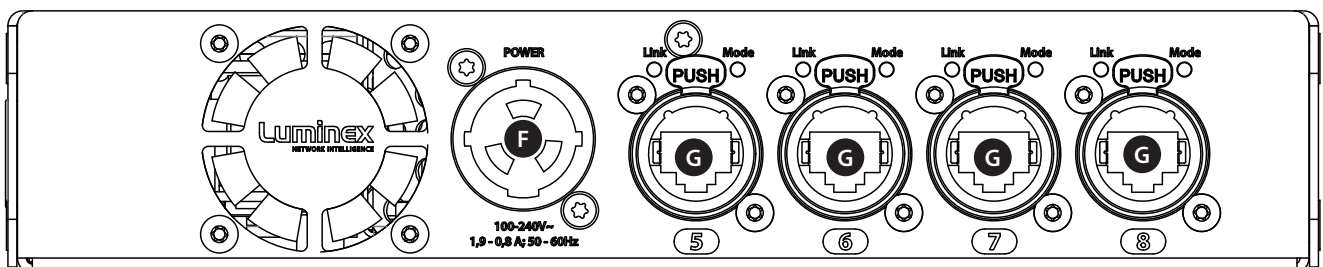

2.4 LED indicators:

The LED indicators of the GigaCore 10 and GigaCore 10 with PoE show the following statuses:

SWITCH LED	COLOUR	DESCRIPTION
OK (General status LED)	Green	All OK
	Green blink	Unit is writing to the flash. Do not disconnect power
	Orange	Temperature warning
	Red blink	Temperature or Fan error
	Red/Green blink	The unit is flashing new firmware. Do not disconnect power
PoE LED (GigaCore 10 with PoE only)	Off	No PoE
	Green	Internal PoE supply
	Red blink	PoE supply or PoE functionality error
RLinkX LED	Green	RLinkX is active
	Red blink	OOS occurred on the switch
Power LED	Green	Internal power supply OK and RPSU connected
	Red blink	Power error
PORT LED	STATUS	DESCRIPTION
PoE LED	Orange	Sourcing
	Off	Not sourcing
RlinkX LED	Blue	Redundant port/link
	Red blink	OOS occurred on that particular port
Link LED	Off	No Link
	Green	Gigabit connection
	Orange	10/100 Mbps connection
	Blink	Activity

2.5 Connecting to the web interface

- The default GigaCore IP address is displayed at the rear of the unit. Set your computer with a compliant IP address (do not use the same IP address!).
- Connect your computer to the GigaCore with a network cable.
- Launch your favourite web browser.
- Type the IP address of the switch in the address field followed by enter.

⚠ PLEASE KEEP IN MIND THE WEB INTERFACE OF A SWITCH CAN ONLY BE REACHED THROUGH A PORT ASSIGNED IN THE MANAGEMENT GROUP (FROM THE SWITCH YOU'RE CONNECTED TO, OR FROM ANOTHER SWITCH THROUGH AN ISL PORT). YOU NEED AT LEAST ONE PORT ASSIGNED TO THE MANAGEMENT GROUP IN YOUR ENTIRE NETWORK TO REACH THE WEB INTERFACE OF ALL YOUR GIGACORE SWITCHES

FACTORY DEFAULT ALL PORTS ARE ASSIGNED TO THE MANAGEMENT GROUP.

2.6 Reset

Sometimes it can come in handy to reset the device. To do this, press and hold the mode button for 5 seconds. Once the four status LEDs blink red, release the button. This will reset all settings to default. The user profiles will be preserved though.

For more detailed information on how to reset the device and what reset options are available please check chapter 5 of this manual.

3. GIGACORE FEATURES EXPLAINED

The GigaCore range of switches offers many unique features which greatly simplify your everyday job. These features will be explained on the following paragraphs.

3.1 RLinkX:

RLinkX, which stands for **Redundant Link** by Lumine**X**, is an automated system to easily create redundant paths between your GigaCore switches. Switches automatically create active and redundant paths, providing an effortless method to create safe networks.

If one of the active paths fails, the switches will enable a redundant path in a seamless manner. The recovery time is between 20 and 40ms. By default, all GigaCore ports have RLinkX enabled, which means you can interconnect any GigaCore switch between each other. All redundant paths will be created automatically by the switches, no need for configuration.

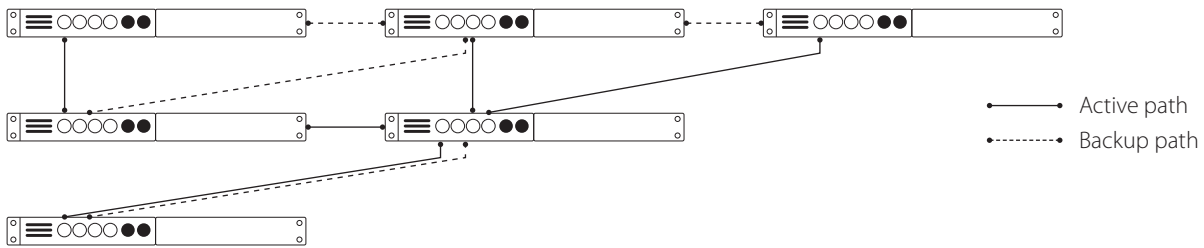

To create a redundant path with RLinkX, simply connect a minimum of two links between two GigaCore switches. The blue RLinkX LEDs of the connected ports will turn on, indicating the redundancy is active and available.

If your port's RLinkX LED turn off, you have lost one of your redundant paths.

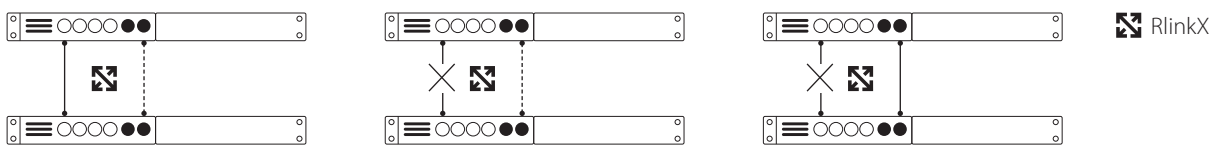

↑
User connects two switches with two links. The switches automatically create a backup link.

↑
Active link becomes unavailable

↑
Backup link becomes active automatically

🕒 20-40ms

3.2 Groups (VLANs)

The groups function allows the user to segment the network into several virtual networks (VLANs). The main benefit of this function is that no group will affect the other ones, on protocol level.

The user can create several groups on the network, and each device included in a group will be able to communicate with devices in this group only. This will result in a better bandwidth, and no protocol conflict.

Three groups have been created in the illustration to the right: Red, Green and Blue. Each device included in each group can communicate with devices from the same group. Thus, the sound console and the sound processor can talk to each other, without being flooded by packets streamed by the two other groups.

The GigaCore switches offer 20 groups, to which the user can assign any of the ports. Two devices must be part of the same group to communicate.

When more than one switch is used in a group-based network, the Inter Switch Link group (ISL Group 0) must be used to forward the group's packages between switches.

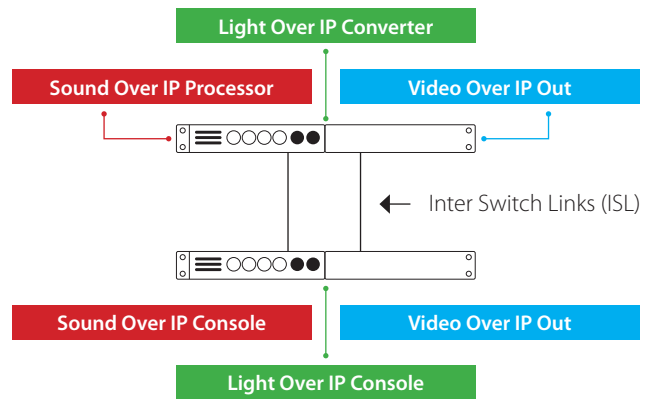

3.3 MultiLinkX:

Most of the time, a redundant link set with RLinkX between two GigaCore switches will be good for the everyday event. A 1000Mbps link is more than enough for most of the current applications. However, it can happen that you'll need to transfer a larger amount of data between the switches.

For example four video transmitters are transmitting four video streams to each dedicated receiver. Each stream requires a throughput of 400Mbps, which represents 1600Mbps in total.

However, only one link is active between the switches, as the other link is used as redundant link. So, a maximum of 1000Mbps data transfer can be achieved on this link. In the above example, we need 1600Mbps of throughput to transfer all four video streams between the switches.

This is not enough, the link between the switches will create a bottleneck, resulting in data loss or data delay. The video streams won't be delivered in time and will create lag in the video output.

The solution? MultiLinkX!

MultiLinkX enables you to gather several links together and turn them into one virtual link (link aggregation). This provides you with more bandwidth between the switches, and thus more throughput. MultiLinkX can accept a maximum of 16 ports per aggregation, and up to 8 aggregations can be created on a switch.

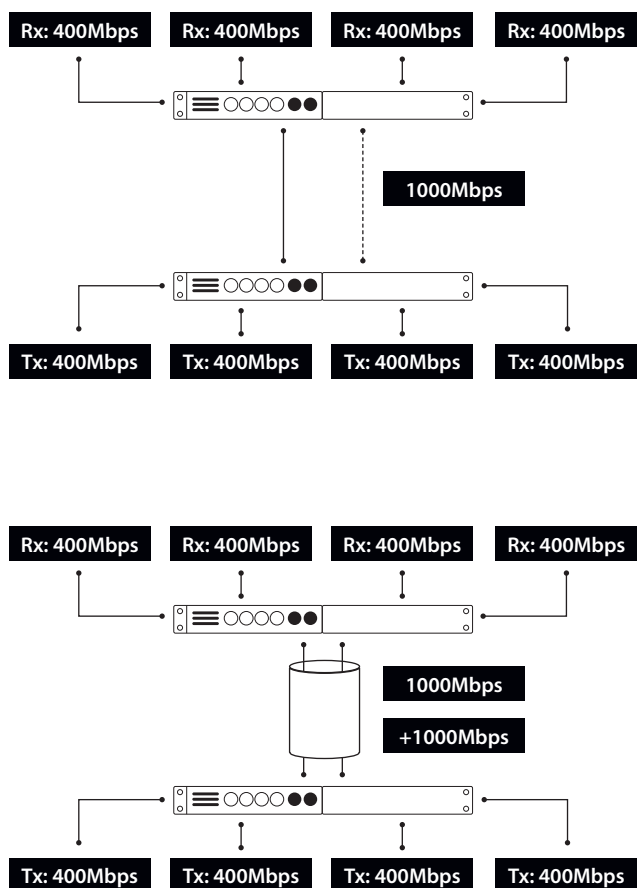

Working with PTPv2 on MultiLinkX

When working with PTPv2 (Precision Time Protocol v2), you'll notice an inverted PTPv2 icon to indicate the PTPv2 enabled port is in an aggregation. You must always link the lowest ports of the active aggregation to each other to avoid problems with the PTPv2. It is recommended to never create a cross link between ports in a different order.



1 + 1 is NOT 2!

By adding an additional link into the aggregation, it's easy to think you'll have double the bandwidth available.

However, MultiLinkX relies on LACP (Link Aggregation Control Protocol). The algorithm used by the protocol requires several parameters of the Ethernet frame to decide to which port of the aggregation the frame will be forwarded.

The protocol uses the following parameters:

- Source Mac Address
- Source IP Address
- Source Port (TCP/UDP)
- Destination IP Address
- Destination Port (TCP/UDP)
- The ports included in the aggregation

In some circumstances it might happen that several data streams will be forwarded to the same port. To know where the data stream will be forwarded to, you can have a look at our aggregation planning web page. Type the following link into the address bar of your favourite web browser: http://IPOFMYSWITCH/aggregation_code.html

According to the parameters of your Ethernet frame, the page will show you which port will be in use. This allows you to predict, but also to solve some problems. In the unlikely event of an overloaded link in an aggregation, the user can solve the problem by simply changing the appropriate IP address for the source, for example.



MultiLinkX technology is available on the ISL ports only! It is also a good habit to allocate the specific number of links in an aggregation to fulfil your throughput requirements, plus one link. If one link fails, you'll still have the minimum number of necessary links to transfer all your data!

Luminex Network Intelligence - Aggregation planning

src mac	00:50:b6:65:32:25
sender ip (ipv4 src ip)	192.168.1.83
ip/udp src port	51247
destination ip(ipv4)	239.255.0.2
ip/udp dst port	5568
Aggregated ports	7,8,9
target_port	7

4. CONFIGURATION

In the next paragraphs we will describe how to configure your GigaCore switch via the built in web interface. An alternative way to configure your switches is via the Araneo software which can be downloaded from our website www.luminex.be/araneo.

PLEASE KEEP IN MIND THE WEB INTERFACE OF A SWITCH CAN ONLY BE REACHED THROUGH A PORT ASSIGNED IN THE MANAGEMENT GROUP (FROM THE SWITCH YOU'RE CONNECTED TO, OR FROM ANOTHER SWITCH THROUGH AN ISL PORT). YOU NEED AT LEAST ONE PORT ASSIGNED TO THE MANAGEMENT GROUP IN YOUR ENTIRE NETWORK TO REACH THE WEB INTERFACE OF ALL YOUR GIGACORE SWITCHES

FACTORY DEFAULT ALL PORTS ARE ASSIGNED TO THE MANAGEMENT GROUP.

4.1 Connecting to the web interface

Every GigaCore switch embeds a built-in web server, which excludes the need of a dedicated application to configure the unit. Browsers such as Chrome, Internet Explorer (IE9 minimum), Firefox or Safari can be used to reach the web server.

Every unit comes with a default IP address, visible at the rear of the unit. Set your computer with an IP address within the same subnet (do not use the same IP address!).

- Example 1: Switch IP address: 192.168.1.1, Netmask 255.255.255.0 / Computer IP address: 192.168.1.2, Netmask 255.255.255.0
- Example 2: Switch IP address: 192.168.2.112, Netmask: 255.255.0.0 / Computer IP address: 192.168.2.113, Netmask 255.255.0.0

Connect your computer to the switch with a network cable and launch your favourite web browser. Type the IP address of the switch in the address field, and press enter. You'll be prompted to enter a login:

Use admin in the user field and leave the password field blank. This takes you to the status page of the GigaCore switch.

4.2 Status Page

The status page is split into several panes:

(A) Switch image: The top image gives you a quick overview of the switch port status (front and rear). Active ports are filled with the following colours:

- Orange: 100Mbps link
- Green: 1000Mbps (1Gbps) link

(B) Identify: The identify feature allows you to easily locate a GigaCore switch in a stack of devices. Click on the Luminex Logo on the switch image, all four status LEDs on the left-hand side of the switch will start blinking three times.

(C) Main menu: On the left-hand side, you can find the main menu. Click on any tab to reach the corresponding menu.

(D) Port status: This table gives you a quick overview of the switch's port settings. Parameters such as port speed and legend can be modified in the following menu: Global > Port Settings.

(E) IP Settings: Find here all the network settings of the switch. These parameters can be modified in the following menu: Global > Device Settings.

(F) System info: Find here all the info of the device such as serial number, device name, system identifier, MAC address, system description, and if a configuration profile is currently in use. This information can be modified in the following menu: Global > Device Settings.

Port	Legend	Group	Speed
1	Port 1	Management	down
2	Port 2	Management	down
3	Port 3	Management	down
4	Port 4	Management	down
5	Port 5	Management	down
6	Port 6	Management	down
7	Port 7	Management	down
8	Port 8	Management	down
9	Port 9	Management	1Gfdx Fiber
10	Port 10	Management	1Gfdx Fiber

IP Settings	
DHCP	Disabled
IP Address	192.168.20.10
Subnet Mask	255.255.255.0
Default Gateway	

System Info	
Serial	LUM0580198
Device Name	GigaCore10
System ID	1
System Description	Luminex Gigacore 10 port
Mac Address	D0:69:9E:02:0B:26
Active Profile	(no profile active)

4.3 Global Page

The global page consists of four sub menus:



4.3.1 Device settings:

This menu allows you to change IP and ID settings of the unit, and the brightness of the port LEDs.

(A) IP settings: Assign here the IP address of your switch. This IP address will be used to reach the switch's web interface. By default, the IP address is set to the IP address provided on the label on the rear of the unit with the serial number and mac address.

There are 3 options to use for the IP address:

- **Static (default)**

Enter your preferred IP address and subnet mask. Enter your default gateway IP address if your switch needs to be reached from a routed network. Press apply to save your changes.

- **Link-Local (zero-conf) (firmware 2.8.4 or higher)**

When using Link-Local the switch will auto assign an IP address in the range 169.254.x.x/16.

- **DHCP (Dynamic Host Configuration Protocol)**

If your network is equipped with a DHCP server, you can enable the DHCP client of the switch for it to receive an IP address automatically from the DHCP server. When DHCP is enabled the user can choose to use a static IP address or the Link-Local option as fallback IP address in case the DHCP server is not available at bootup.

(B) ID settings: Set the name of your switch here and add a description to easily identify your switch in your network.

(C) IGMP (Internet Group Management Protocol): Enable or Disable the IGMP unknown-flooding state here. When enabled all unregistered multicast traffic is forwarded regardless.

(D) Enable SNMP (Simple Network Management Protocol): Here you can configure whether you want to use SNMP. Enabling or Disabling SNMP requires a reboot of the device.

4.3.2 Port Settings:

This menu allows you to change the port's speed, add a legend to each port and enable remote monitoring per port.

The port speed drop-down menu offers the following options:

- Disabled: Disable the port. The port will appear greyed out on the top switch image.
- Auto: The port automatically detects the speed of the connected device (default).
- 10Mbps HDX: 10Mbps Half Duplex
- 10Mbps FDX: 10Mbps Full Duplex
- 100Mbps HDX: 100Mbps Half Duplex
- 100Mbps FDX: 100Mbps Full Duplex
- 1Gbps FDX: 1000Mbps Full Duplex

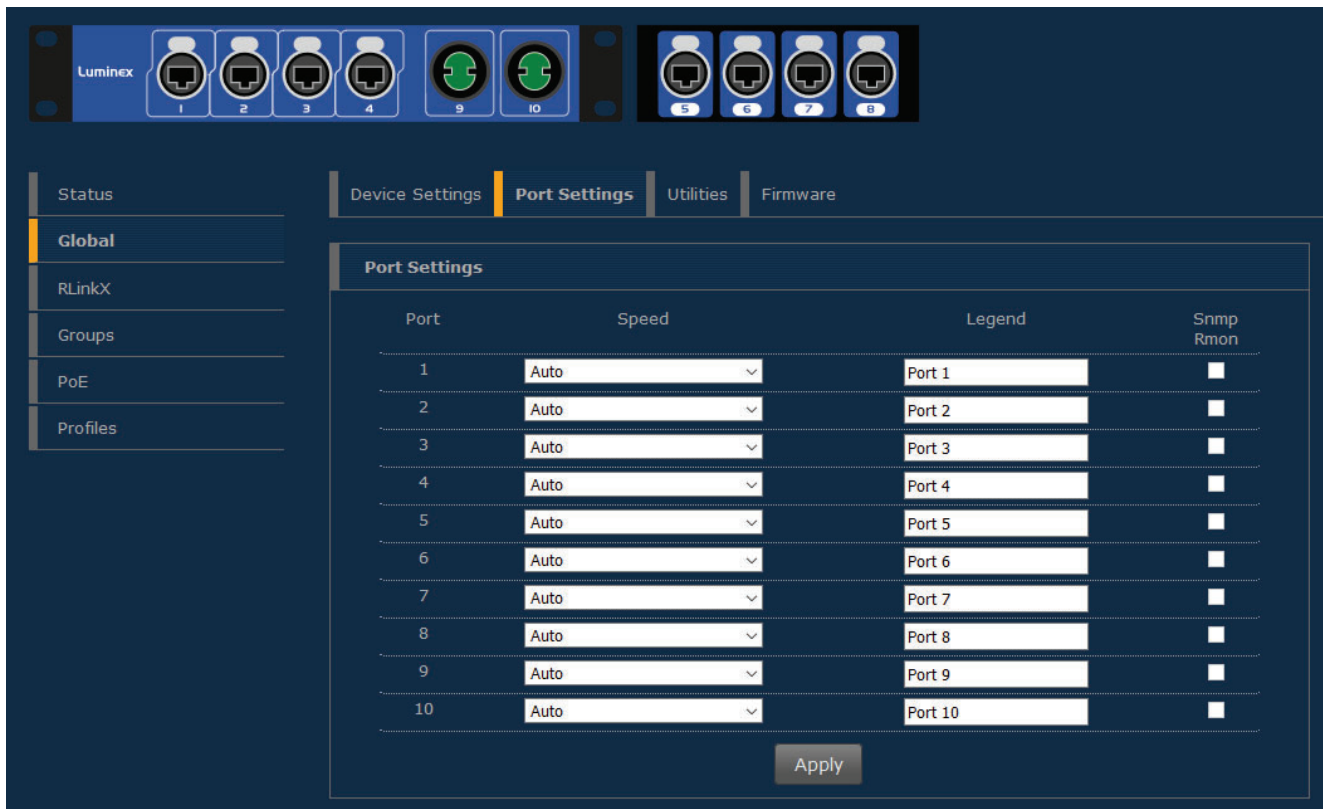

4.3.3 Utilities:

This page brings you the tools to reset your device in different ways and set some default security parameters.

(A) Reset: This menu allows the user to bring the switch into different levels of reset:

1. Preserve IP Settings: Tick the upper checkbox if you wish to bring the device back to the default settings but keep the actual IP parameters set on the device.

If you leave this checkbox unticked, the device will set the IP address back to the factory default address printed on the label on the rear of the device.

2. Preserve all user profiles: Tick the lower checkbox if you wish to bring the device back to the default settings but keep all the profiles stored in the profile manager.

Press "Apply Reset" once you have selected the appropriate options for your reset. Resetting the device with both checkboxes unticked will bring the device back to factory default.

(B) Reboot: Press the “Reboot Now” button to reboot the device. All your settings will be preserved.

From firmware 2.8.4 and higher an auto reboot option in case of timestamp offset has been added.

Very seldomly and only for the following scenario, an offset on the hardware timestamp may occur.

When the GigaCore is used with PTPv2 or AVB (gPTP) enabled on fiber ports (Not applicable for copper ports), and if only a small fraction of a packet did already arrive on the fiber port, when the port was disconnected. In that particular event the hardware timestamping may be offset.

GigaCore measures this offset at disconnection and checks if it is faulty. In the rare case it is indeed considered faulty, the only way to recover from this offset is to restart the switch and thus reset the fiber PHYs to eliminate the offset. This is needed to have a synchronized system. Via the utilities web page of the

GigaCore, the user can now choose to reboot automatically if this (Out-OfSync symptom) occurs. By default, the auto reboot is disabled.

If the offset occurs on the fiber port, the port mode LED will blink RED to indicate the problem. A message will also be displayed in Araneo and the web UI of the GigaCore (E).

If the user does not opt for automatic reboot of the switch, then the affected fiber link will automatically get a different path cost in case it concerns a designated port. This means that the link will not be your primary link in case you have a redundant path available (example: ring connection).

In case the switch does reboot, a persistent reboot reason will be logged into the switch.

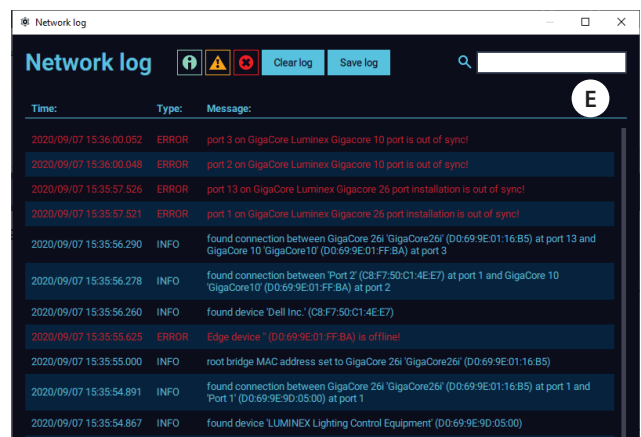
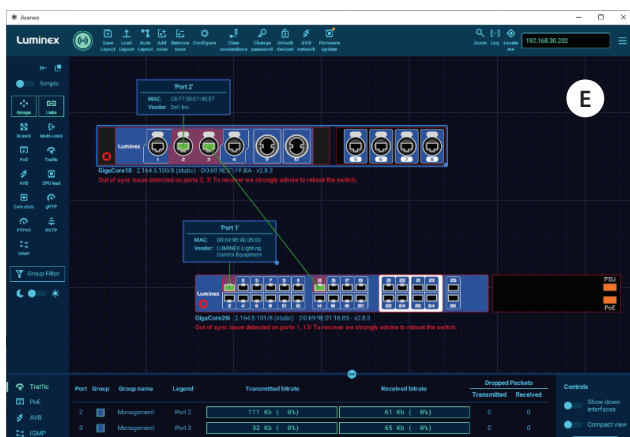
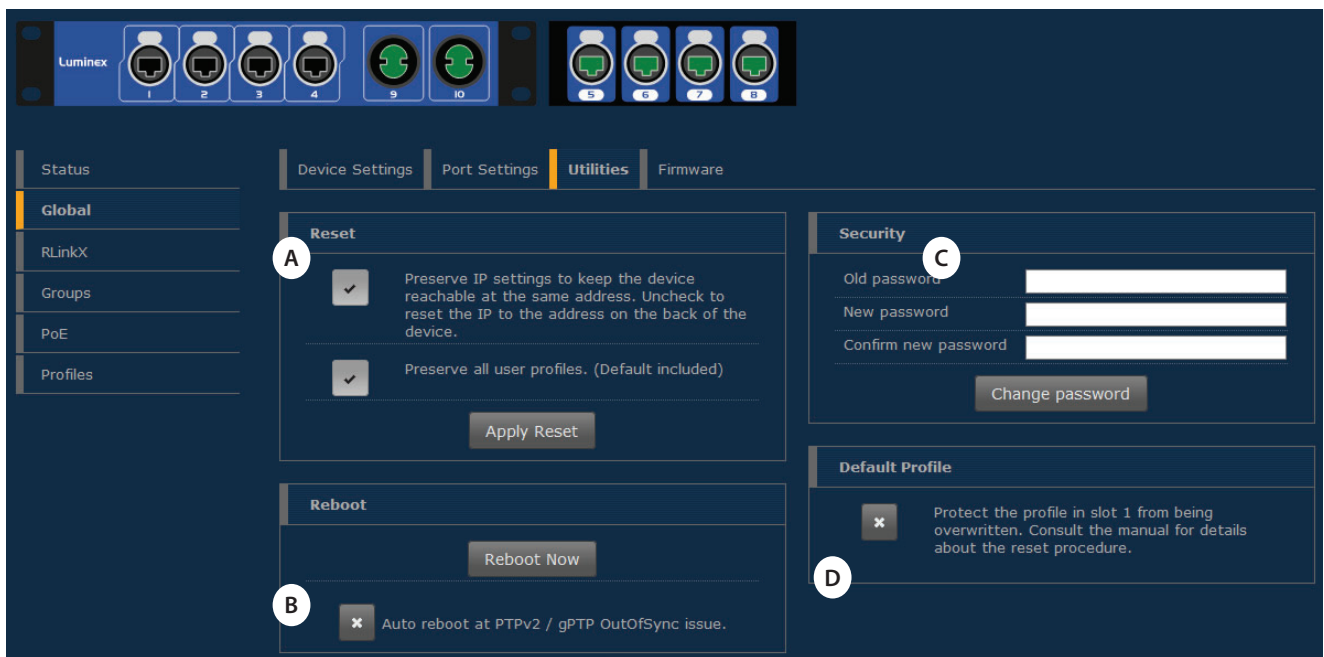

(C) Security: The user can use this feature to set a password to protect the access to the web interface. The default login for the web interface is: Username admin and leave the password field blank. Click on “Change password” to apply your new settings.

(D) Default profile: By clicking on the checkbox the user can protect the profile stored in slot 1 from being deleted or overwritten. When the user performs a Reload Default from the front panel’s mode button (see Reload Default later in this manual), the device will be re-boot into profile 1. This is a handy tool to quickly recall your favourite profile.

Once the first profile is protected and set as default, a padlock will appear on slot 1 on the profile tab.

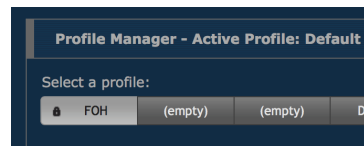
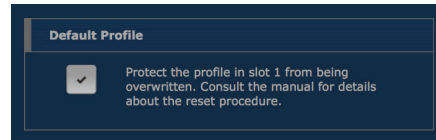

4.3.4 Firmware:

This menu allows you to upload a new firmware version to the switch. Please visit the support section of our website to get the latest firmware available for your GigaCore switch. To upgrade the switch, click on the Upload Firmware button and select the firmware file you saved on your computer. The upgrade procedure takes about 4 minutes to complete.

Alternate image:

If you’re not satisfied with your recently uploaded firmware you can reload the previous firmware version that was installed on the switch. Press the Activate alternate firmware button to reload the previous firmware. The downgrade process takes about 1 minute.

⚠ WARNING: DO NOT DISCONNECT POWER DURING FIRMWARE UPGRADE

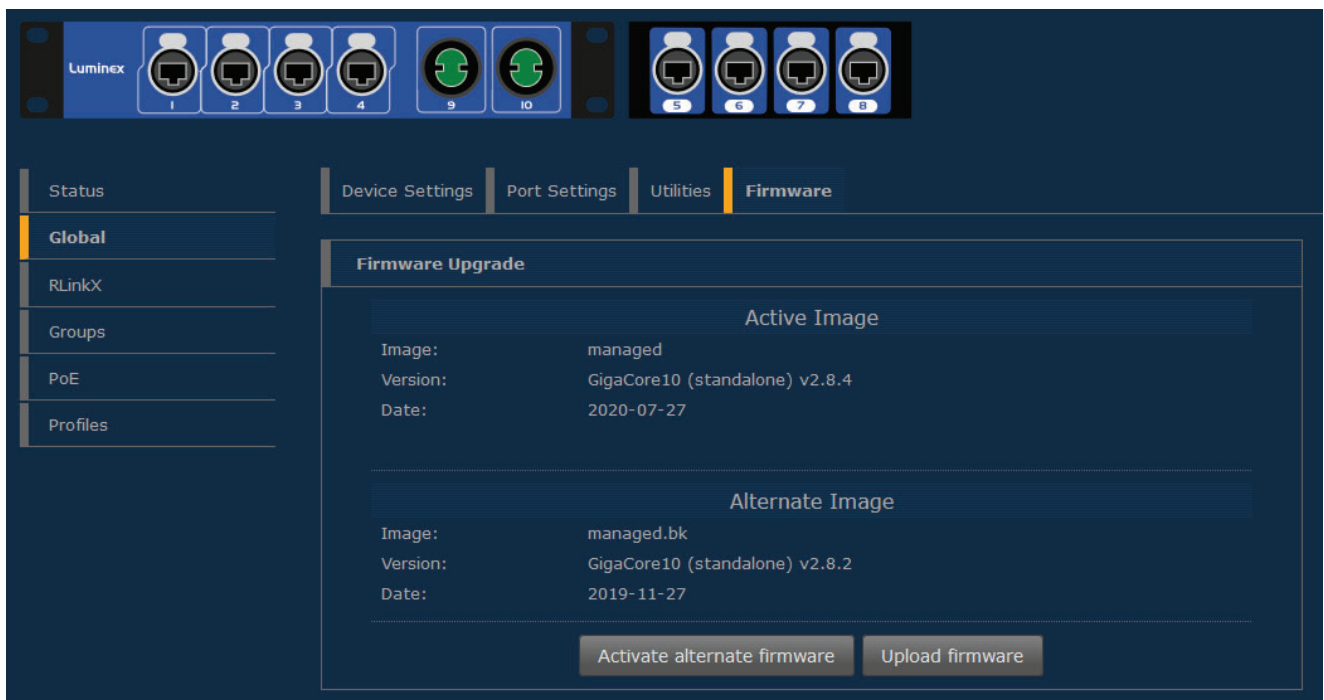

4.4 RLinkX

RLinkX is designed to provide a plug and play redundant system. This menu allows you to enable/disable RLinkX on each port of the switch. A port with RLinkX enabled is represented by a blue circle around the port.

RLinkX Settings:

To enable/disable RLinkX on a port follow the following steps:

- A. Click on the port(s) you wish to select. Selected ports will be highlighted.
- B. Choose Enable On/Off.
- C. Click Apply to submit the changes.

It is sometimes useful to disable RLinkX on some of the ports on the GigaCore as some devices do not comply with the RLinkX packet the switch sends out periodically to maintain its redundant link.

Once a minimum of two links are connected between two switches the blue LEDs on these ports will light up indicating the redundancy is active and operational.

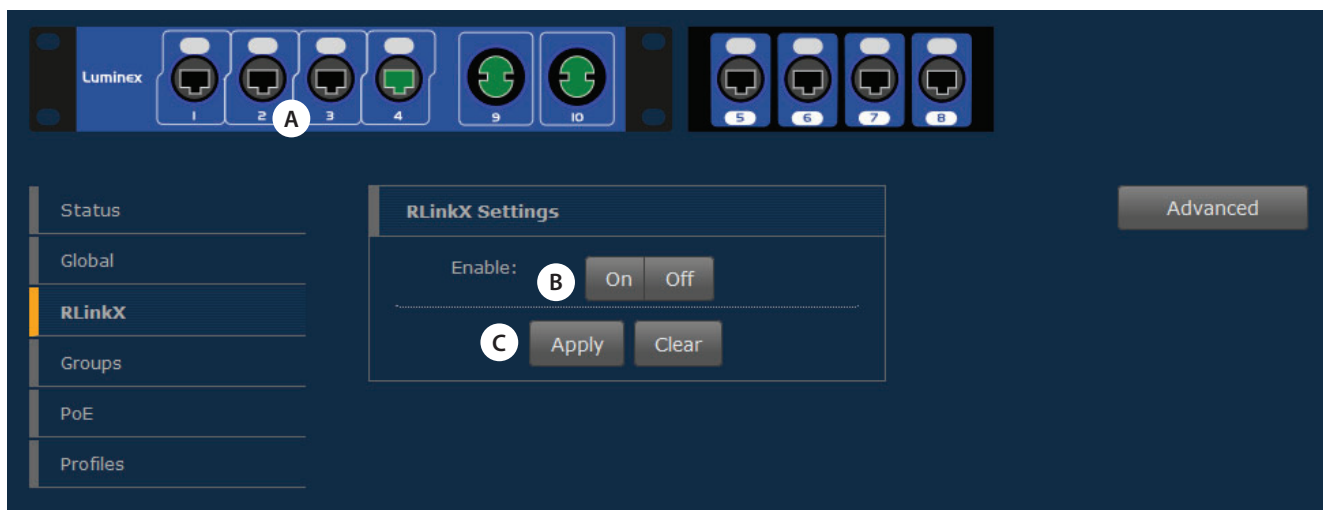

4.4.1 Advanced:

MultiLinkX, our aggregation protocol, has been designed to work flawlessly with RLinkX, our redundancy protocol.

To provide users with a more advanced and efficient method to recover topology in case of a link failure, Luminex has developed a new method for best link cost calculation in an aggregated network based on the available bandwidth per link.

This calculation method is the default one when using MultiLinkX.

However, in the case you would have to connect your aggregated links to an existing IT network, best is to select the usual path cost calculation based on RSTP.

To select this method, click on the Advanced button and select RSTP as link cost. Press apply to submit your changes.

When a user connects a minimum of two aggregated links between two switches, it is easy to think these are redundant links. However, this is seen as a unique link between the switches. Therefore, the RLinkX LED won't lit up. This is normal behaviour.

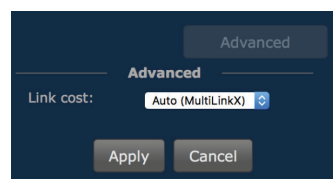

4.5 Groups (VLANs)

Groups is a technology which offers the user to easily segment the network into several virtual networks (VLANs).

This menu allows the user to assign ports to one of the 20 embedded groups of the switch.

A group is a combination of ports and the user can assign as many ports as they want to a group.

The GigaCore range offers three types of groups:

- Group 0 (ISL): This group is dedicated to the Inter Switch Link (trunk). This is the name given to the interconnection links between GigaCore switches in a network. The ISL links are meant to forward the group-based packets. When RLinkX is enabled on these inter switch links, then the GigaCore knows that there is another GigaCore on the other side of the link. If you already have connected your these links, then click on the advanced button and press **"Retrieve from RLinkX"**. The switch will automatically assign the linked ports as ISL ports.
- Group 1 (Management): This group is dedicated to the management of the switch (web interface). You need to have at least one port of the switch assigned to the management group to be able to reach the web interface. In a star, ring or mesh network topology comprised of GigaCore switches you need to have at least one port on one of the switches set in this group in order to be able to reach the web interface of any of the switches.
- Group 2 to 20: These are the generic groups to be used for any purpose such as sound, lighting, intercom, video....

To assign ports to a group please follow the following steps:

A. Select the group you wish to assign ports to. Use the coloured index of the jog and rotate the jog to change the group. If you wish to change the name of the group, click on the **"Name"** button. A name window appears to rename the group. Click **"Apply"** to confirm your changes. Without **"Apply"** or **"Cancel"** to finish the name change you can't access any other groups.

B. Select the ports you wish to assign to the group. Selected ports will be highlighted.

C. Click on the **"Assign"** button to assign the ports to the group. The selected ports will now change to the colour of the selected group. If you are not satisfied with the selection of ports and wish to restart your selection you can click the **"Clear"** button to reset the selection.

⚠ PLEASE KEEP IN MIND THE WEB INTERFACE OF A SWITCH CAN ONLY BE REACHED THROUGH A PORT ASSIGNED IN THE MANAGEMENT GROUP (FROM THE SWITCH YOU'RE CONNECTED TO, OR FROM ANOTHER SWITCH THROUGH AN ISL PORT). YOU NEED AT LEAST ONE PORT ASSIGNED TO THE MANAGEMENT GROUP IN YOUR ENTIRE NETWORK TO REACH THE WEB INTERFACE OF ALL YOUR GIGACORE SWITCHES.



4.5.1 Advanced:

The advanced pane offers the user access to extended parameters such as:

- **VID:** Luminex group technology relies on the 802.1Q VLAN protocol. By default, Luminex groups have a default VLAN ID. If required, the user can change the VID of the group. Be aware that if you wish to change this VID you'll have to change it on all the switches using this group.

- **IGMP** (Internet Group Management Protocol)
IGMP is required when using multicast protocols

Snooping: This button activates IGMP snooping. IGMP snooping is a smart way to manage multicast packets and forward them to the registered ports. The main advantage of the IGMP snooping is to avoid ports to be flooded with unrequested packets.

Querier: IGMP snooping requires at least one switch in a group to act as a querier. The querier registers the multicast packets to the corresponding ports. If more than one querier is activated per group, the switch with the lowest IP address will be elected as querier. This election process is automated.

- **PTPv2 (Precision Time Protocol)**

The Precision Time Protocol is a protocol used to synchronize clocks throughout a computer network. On a local area network, it achieves clock accuracy in the sub-microsecond range, making it suitable for measurement and control systems.

GigaCore supports both PTP v1 and v2 packets. PTPv1 (used by protocols like Dante) is prioritized by the built in DiffServ / QoS settings. In case of PTP v2 (IEEE1588-2008), the switch actively takes part in clocking protocol by timestamping packets at the hardware level.

With PTPv2 the GigaCore can be part of the clock domain which is necessary for protocols such as AES67.

The user can enable/disable PTPv2 communications within the selected group by validating the tick box and by selecting the mode that best fit the setup.

- E2E – End to End
The E2E delay mechanism measures the delay from the Slave to the Master.
- P2P – Peer to Peer
The P2P delay mechanism measures the delay between two nodes only independent of their states.

Domain: please enter a value for your PTP domain here.

Press Apply to submit your changes. You can have only one PTP setup per switch, so in one group only.

In the status page, a stopwatch will be displayed for every port set in the group associated to a PTP domain.

- **AVB:** The GigaCore switches fully support AVB/AVB Milan. In order to configure a group to be used for AVB, select the group, click the advanced options and tick the box AVB.

A warning screen will pop up to warn you for the following:

- PTPv2 is disabled in every group.
- MultiLinkX (aggregation) is disabled.
- VID 2 is not permitted for a group.
- Only use 100Mbps/1Gbps FDX port links.
- AVB can only be active in one group.

A button “**legacy SET 1**” has been added to enable compatibility with devices that expect two declarations instead of one after a LeaveAll of the MSRP protocol. Some legacy devices expect / need separate declaration(s).The following warning will be given when choosing this option:

- Warning: Enabling this button makes the LeaveAll to send 2 iso 1 joinMts. This option can be needed as workaround in combination with some non Avnu/Milan certified components.

The screenshot shows the 'Advanced' configuration pane for a group. It features several sections with checkboxes and dropdown menus:

- VID:** A text input field containing the value '200'.
- IGMP:** A section with a checked checkbox for 'Snooping' and a checked checkbox for 'Querier'.
- PTP:** A section with an unchecked checkbox for 'PTPv2'. Below it, a 'Mode' dropdown menu is set to 'E2E', with 'P2P' also visible as an option.
- Domain:** A text input field containing the value '0'.
- AVB:** A section with an unchecked checkbox for 'Enabled'.
- Legacy SET 1:** A section with an unchecked checkbox and the text '(Not Milan compliant!)' next to it.

At the bottom of the pane are two buttons: 'Apply' and 'Cancel'.

4.5.2 MultiLinkX:

MultiLinkX (also known as link aggregation) allows you to gather several links together in order to increase the available bandwidth between switches. MultiLinkX is available for ISL ports only.

To enable MultiLinkX you first select group zero (ISL) on the group page. Select the "Advanced" option and tick the box "Enabled" under the text MultiLinkX. Press apply to submit the changes.

Once MultiLinkX is enabled on the ISL ports, a Magenta bar will appear below/above the selected ports.

Once MultiLinkX is active on the ISL ports, the Magenta bar will turn White.

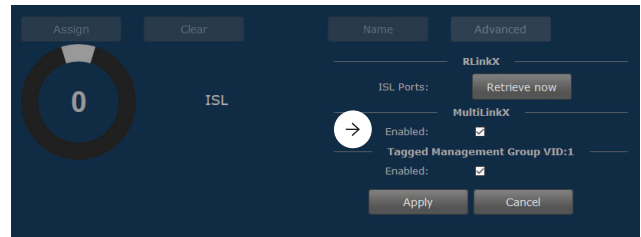

4.5.3 Tagged Management Group VID 1:

Sometimes it is required to integrate GigaCore switches with third party hardware. In some systems the management group needs to be untagged in the ISL group. On the GigaCore switches the management group is tagged by default.

To un-tag the management group VID:1, select group zero (ISL) on the group page. Select the "Advanced" option and un-tick the box "Enabled" under the text Tagged Management Group VID:1. Press apply to submit the changes.

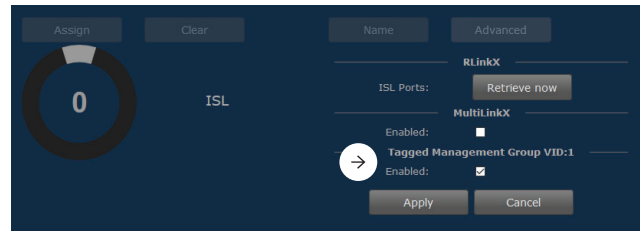

4.6 PoE: (LU 01 00058-POE only):

PoE (Power over Ethernet) is a convenient way to transport both data and power over the same network cable and doing so powering a device with its data cable. Your GigaCore switch can then be a data connection hub and power source for your end devices.

PoE supply will provide PoE enabled ports as a default configuration (see the upper illustration on page 21).

A PoE enabled port is displayed with a yellow latch above the port. When the switch is currently sourcing a PoE device through a port, the latch will turn orange, as is the port LED on the front.

The PoE status page will offer the following information per port:

- The Powered Device Class (0, 1, 2, ...)
- The power consumption (Watts)
- The current consumption (mA)
- The priority (low, high, critical)
- The port status

On the right-hand side of the page, a bar graph displays the current power consumption of the switch. The switch can deliver a total of 130W to share on the 8 EtherCon ports, with a maximum of 30W per port. (PoE+ compliant).

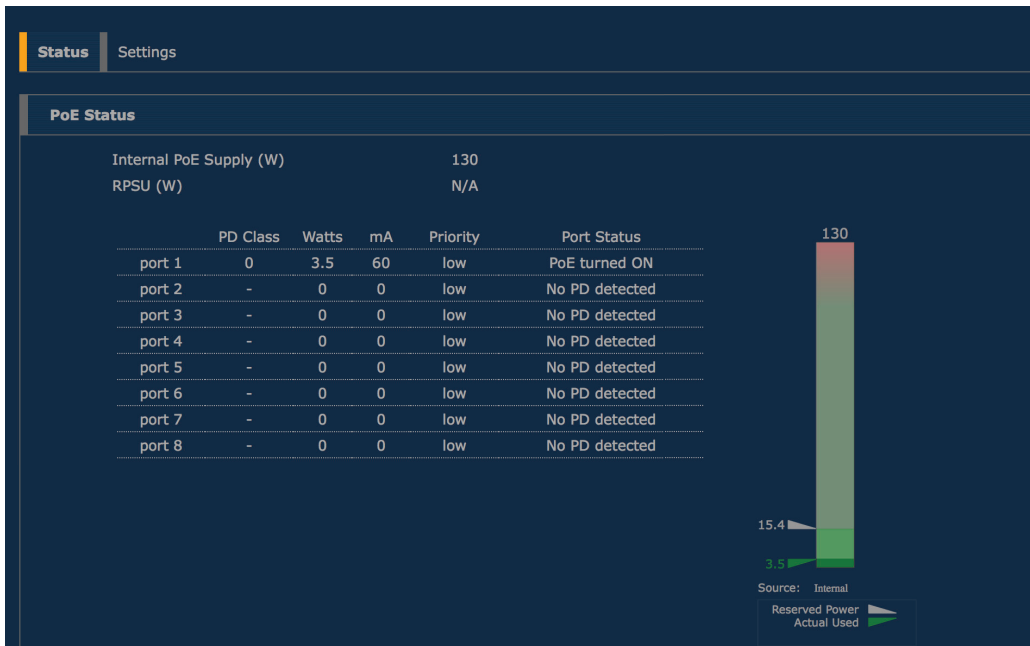

Two arrows will indicate the following values:

- **Allocated power:** based on the classes of the connected PoE devices, the switch will allocate the necessary power to the PoE supply. This value is represented with a grey index.
- **Actual usage:** a green index will show the current power delivered by the PoE supply.

4.6.1 PoE Settings:

The settings page allows you to assign the following PoE parameters to the 8 EtherCon ports:

- Enable/Disable PoE per port
- Assign a priority on the port

To change the PoE parameters of one or several ports please apply the following procedure:

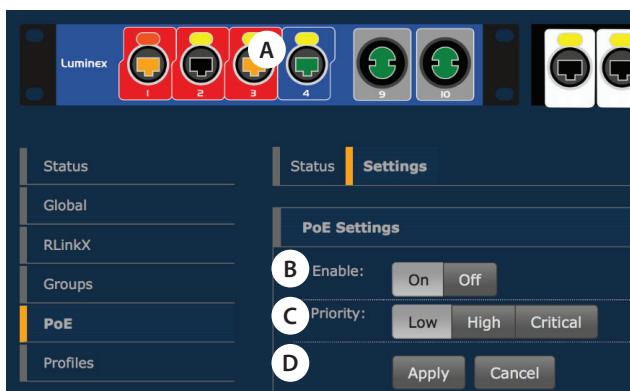

- Select the port(s) you wish to modify
- Enable or disable these port(s)
- Select the priority for the port(s)
- Apply your new parameters

The priority of a port is used when the switch reaches the limit of its maximum output power.

In the unlikely situation of the PoE devices requiring too much power from the switch, the switch will first disable the port(s) with the lowest priority

4.6.2 PoE Advanced:

In the advanced PoE settings the user has the option to configure the following options:

Management type:

- Class (PoE classification)
- LLDP (Link Layer Discovery Protocol)

Power Budget:

- Consumption, the actual consumed power is being used to determine the maximum output power.
- Reserved, the class is used to reserve the maximum allowed power for that class to determine the maximum output power.

4.7 Profile Manager

The profile manager allows the user to easily save / recall / export or import a configuration.

A profile will contain the following parameters:

- Device settings
- Port settings
- RLinkX settings
- Group settings
- PoE settings

This way the user can create a comprehensive configuration for a switch, save it as a profile, and recall it later when needed.

A maximum of ten profiles can be saved on a GigaCore switch.

The switch also offers to export or import a profile through a computer, providing the user with an easy way to exchange profiles between switches.

From one switch, the user can select a profile to export to a computer. Then, from the same computer, the user will be able to load this profile into an empty slot on another switch.

Exchanging profiles between switches can be a time saving process. The user may start with one base configuration and export it to the other switches for minor changes. These newly created profiles will then be saved locally.



4.7.1 Saving a Profile:

If you wish to save the actual configuration of your switch, first select an empty slot amongst the 10 available slots. Press the **Save** button. A small window will pop-up to enter the name of the profile.

Click on **OK**. Your profile is now saved in the switch.

It is good practice to always create a **default configuration** for your switch!

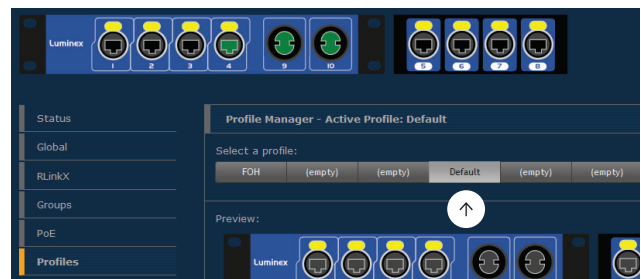
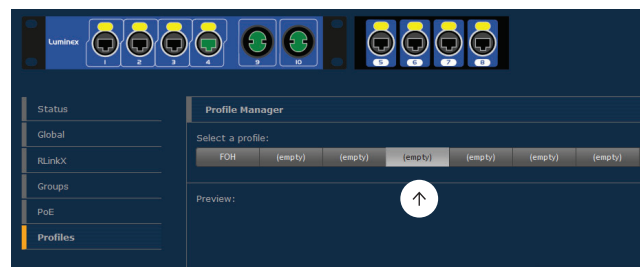

4.7.2 Recall a Profile:

To recall a profile, select it amongst the ten available profiles in the upper tab. Here you can preview the content of this profile.

Click on the **Recall** button. A window will pop-up to let you select either to reload all the configuration settings (Recall All), including the network settings, or just the switch configuration (No Network Settings). This very useful feature makes the exchange of profiles between switches possible. You can thus avoid getting the same IP address twice in the network by using the same profile.

Once you have selected the profile you wish to recall, the switch will reboot and will reload the requested profile.

The recall process can take a minimum of 30 seconds to a maximum of 2 minutes.

If you intend to reload a profile with a different IP address, you can try to reach the newly loaded IP address after about 50 seconds, manually from the switch's web interface.

Otherwise, the web interface of the switch will be automatically reloaded after a maximum of 2 minutes. Your computer's IP address needs to be set in the same subnet mask as the loaded profile's IP.

4.7.3 Export a profile:

To export a profile, select it amongst the ten available slots. Once selected, click the **Export** button to download the profile to your computer. You'll be asked to select the download location of the profile on your computer.

4.7.4 Import a Profile:

To import a profile, select an empty slot in the profile manager tab. Once selected click the **Import** button to select the profile on your computer. Once the file is selected, validate to import the profile in the empty slot. A message will confirm the successful import process.

4.7.5 Delete a Profile:

To delete a profile, select the profile in question and click **Delete**. The profile will automatically be erased, and the preview window will display an empty space.

⚠ WHEN USERS SAVE A PROFILE, THE OK LED WILL BLINK GREEN FOR ABOUT 5 SECONDS TO INDICATE THE WRITING PROCESS TO THE FLASH MEMORY. PLEASE DO NOT SWITCH OFF POWER TO THE UNIT WHILE THE OK LED IS BLINKING GREEN! YOUR SWITCH CONFIGURATION MIGHT BE ERASED DURING THE NEXT BOOT UP.

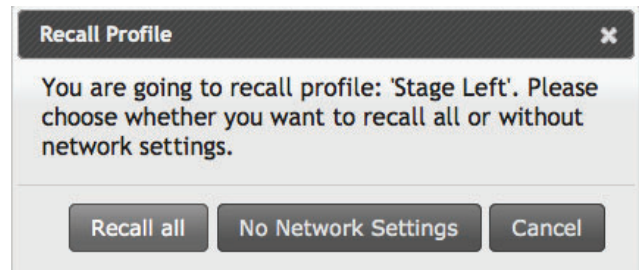

⚠ PLEASE KEEP IN MIND THE WEB INTERFACE OF A SWITCH CAN ONLY BE REACHED THROUGH A PORT ASSIGNED IN THE MANAGEMENT GROUP (FROM THE SWITCH YOU'RE CONNECTED TO, OR FROM ANOTHER SWITCH THROUGH AN ISL PORT). PAY ATTENTION THE PROFILE YOU'RE GOING TO RECALL IS NOT CHANGING YOUR LINK TO THE WEB INTERFACE OF THE SWITCH YOU'RE WORKING WITH. ALSO PAY ATTENTION THAT THE IP ADDRESS THAT WILL BE RELOADED WITH THE PROFILE DOESN'T CONFLICT WITH ANOTHER IP IN THE NETWORK. THE SWITCH'S WEB INTERFACE MAY BECOME UNRESPONSIVE IN CASE OF AN IP CONFLICT.

4.7.6 Default Profile:

As described in section 3.3.3, the first slot of the profile manager can be locked. This will be indicated by a padlock on the profile itself. This profile can't be erased nor overwritten, unless you unlock it. To unlock the profile, untick the checkbox in Global>Utilities.

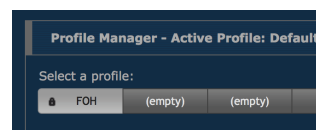

5. RESET

In the case you need to reset the unit without the web interface, the GigaCore 10 and GigaCore 10 with PoE offers different levels of reset, based on the ones you can find in the web interface.

- **Reset:** The unit is brought back to its default configuration, with the default IP address printed at the back of the unit. Profiles stored in the device are preserved

Default login: admin
Default password: No password

- **Reload Default:** The profile stored in slot one is reloaded. The "Reload Default" is available only if the profile stored in slot one has been locked through the utility menu. If this profile is set with a password, then the user will need to enter it through the web interface to access the switch's menu.

Default login: admin
Default password: No password

- **Factory Reset:** With a factory reset the device is fully reset to the state it left Luminex and ALL data will be erased.

Default login: admin
Default password: No password

4.1 Reset

Condition 1: The device is currently running
Condition 2: There is no profile set as default profile

Hold the mode button for at least five seconds to see the four status LEDs blink red. Releasing the mode button while the LEDs are blinking red will reset the unit.

Be aware that releasing the mode button during the first five seconds before the LEDs start blinking red will cancel the operation.

Be aware that releasing the mode button during the five seconds after the LEDs are blinking red will cancel the operation.

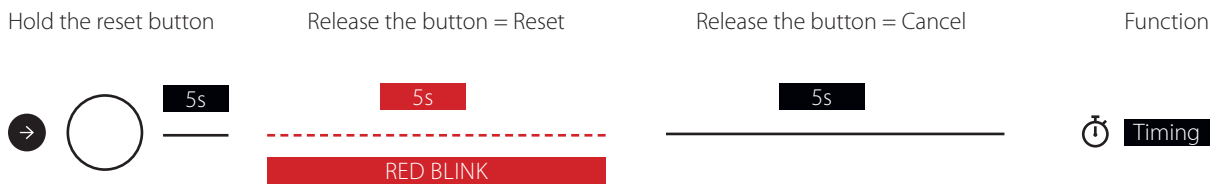

5.2 Reload Default

Condition 1: The device is currently running
Condition 2: The profile stored in slot one needs to be locked through the utility menu

Hold the mode button for at least five seconds to see the four status LEDs start blinking green. If you release the button whilst the LEDs are blinking green, the unit will reload the profile stored in slot one.

If you wait an additional five seconds, the status LEDs will start blinking red to provide you with a reset.

Releasing the mode button while the LEDs are blinking red will reset the unit.

Be aware that releasing the mode button during the first five seconds before the status LEDs are blinking green will cancel the operation.

Be aware that releasing the mode button during the five seconds after the status LEDs were blinking red will cancel the operation.

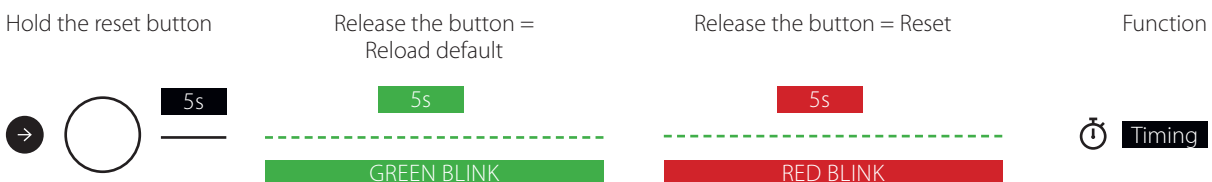

5.3 Factory Reset

Condition 1: The device is switched OFF

Hold the mode button while connecting the device to mains power. After a few seconds the four status LEDs will start blinking red. Releasing the mode button while the LEDs are blinking red will factory reset the device.

Be aware that releasing the mode button before the status LEDs are blinking red will cancel the operation.

Be aware that releasing the mode button after the status LEDs stopped blinking red will cancel the operation.

Hold the reset button while powering the unit

Release the button = Factory Reset

Release the button = Cancel

Function



6. TECHNICAL SUPPORT

Sometimes it is required to get more help with your device or application. There is a knowledge base available online that gets updated on a regular basis at: <https://support.luminex.be>

If you need to ask our team for more help or you need to return a device to Luminex for diagnostics or repair, you can also find the option on this page to request an RMA or start a support ticket.

7. APPENDIX

7.1 TECHNICAL DATA

Mains Voltage:	100 – 240VAC
Main Frequency:	50/60Hz
Power consumption:	Max 20W (non-PoE) Max 150W (PoE)
External fuse:	No
Dimensions (W x D x H):	220 x 330 x 44 mm (19" x 12.99" x 1.73")
Weight:	2.8 kg
Operating temperature:	0 to +50°C (non-PoE) 0 to +40°C (PoE)
Storage temperature:	-10 to +70°C
Humidity (non-condensing):	5 to 95%
Certificates / Approvals:	cSGSUS Mark (UL), CE, CB certificate
Standards:	IEC 60950-1, EN 60950-1, UL 60950-1, CAN/CSA-C22.2 No. 60950-1, FCC Part 15 CFR 47 class A, CAN.ICES-003, EN 61000, EN 55032 class A, EN 55024, RoHS, Reach
Ethernet compliance:	IEEE 802.3, IEEE 802.3u, IEEE 802.3x Flow Control, IEEE 802.3ab Gigabit Ethernet, IEEE 802.1p CoS (Class of Service), DiffServ (DSCP), PoE (802.3af) (optional), PoE+ (optional), IEEE 1588 PTPv2
Sound protocol compliance:	Yes (low jitter)

DISCLAIMER

Luminex LCE operates a policy of continuous development. Luminex LCE reserves the right to make changes and improvements to any of the products described in this document above without prior notice. Specifications are subject to change without notice.

Copyright © 2002-2021.

All rights reserved.

No part of this documentation may be reproduced or transmitted in any form or by any means, electronic or mechanical, including photocopying and recording, without the prior written permission of Luminex. The information in this documentation is supplied without warranty of any kind, either directly or indirectly, and is subject to change without prior written notice. Luminex, its employees or appointed representatives will not be held responsible for any damages to software, hardware, or data, howsoever arising as a direct or indirect result of the product(s) mentioned herein.

Luminex
NETWORK INTELLIGENCE

YOUR NETWORK SOLUTION FOR
AUDIO, VIDEO AND LIGHTING

EFFECTIVE, RELIABLE, ACCESSIBLE



Luminex

Slamstraat 13 | 3600 Genk | Belgium | T +32 11 812 189 | info@luminex.be | www.luminex.world